

## Final Report

Inter-comparison of calibration of  
a turbine gas meter G6500

**EURAMET Project No. 1469**



Flow

**Tomáš Valenta**  
*(Czech Metrology Institute)*

**February 26, 2020**



## Contents

1. Introduction .....	3
2. Instrument .....	4
3. Calibration procedure.....	7
4. Test facility and obtained results .....	8
4.1. Czech Republic .....	8
4.2. Denmark .....	10
4.3. France .....	12
5. Stability of the meter and the dependency of laboratories.....	14
6. Determination of the reference values in determined flow rates .....	15
6.1. Description of the method .....	15
6.1.1. The determination of the Key Comparison Reference Value (KCRV) and its uncertainty.....	16
6.1.2. The determination of the differences “Lab to KCRV” as well as their uncertainties and Degrees of Equivalence .....	17
6.2. Flow rate 10000 m <sup>3</sup> /h.....	18
6.3. Flow rate 8000 m <sup>3</sup> /h.....	19
6.4. Flow rate 6500 m <sup>3</sup> /h.....	20
6.5. Flow rate 5000 m <sup>3</sup> /h.....	22
6.6. Flow rate 4000 m <sup>3</sup> /h.....	23
6.7. Flow rate 3000 m <sup>3</sup> /h.....	24
6.8. Flow rate 2000 m <sup>3</sup> /h.....	25
6.9. Flow rate 1000 m <sup>3</sup> /h.....	26
7. Results.....	27
7.1. France - Independent laboratory .....	27
7.2. Czech Republic - Dependent laboratory (to PTB).....	28
7.3. Denmark - Dependent laboratory (to VSL).....	29
8. Summary and conclusion .....	30

## 1. Introduction

The project EURAMET no.1469 was a comparison of calibrations of an axial turbine gas meter G6500. It officially started in August 2019 and was concluded in January 2020. The planned time schedule is shown in *table 1*. Each country took three weeks to perform the calibration of the turbine gas meter G6500 with air in the pressure which is close to barometric pressure. The range of flow rates was from 1000 m<sup>3</sup>/h to 10000 m<sup>3</sup>/h. The participating laboratories used their usual calibration procedure. The comparison was conducted with respect to guidelines<sup>1)</sup>.

Two participant of this project France and Denmark participates in the similar EURAMET project no. 1333 in 2016. In the moment when this report is issued, no CIPM key comparison was finished in the field of low pressure gas flow in relevant flow rates. That is why this inter-comparison is EURAMET supplementary comparison.

*Table 1 – Time schedule and participants*

Country	Laboratory	Address of the place of calibration	e-mail telephone	Date of calibration	Responsible person
Czech Republic (PILOT LAB)	Czech Metrology Institute (CMI)	Czech Metrology Institute Gas Flow Department Prumyslova 455 530 03 Pardubice Czech Republic	<a href="mailto:tvalenta@cmi.cz">tvalenta@cmi.cz</a>  +420 466 670 728	20.8.-10.9. 2019	Tomas Valenta
Denmark	FORCE Technology	FORCE Technology, Vejen, Navervej 1 6600 Vejen Denmark	<a href="mailto:jrb@force.dk">jrb@force.dk</a>  +45 43 25 06 20	10.9.-1.10. 2019	Jesper Busk

1) - for CIPM key comparisons <http://www.bipm.org/utis/en/pdf/guidelines.pdf>  
- for EURAMET comparisons – EURAMET Guide no.4  
[https://www.euramet.org/get/?tx\\_stag\\_base%5Bfile%5D=31515&tx\\_stag\\_base%5Baction%5D=downloadRaw&tx\\_stag\\_base%5Bcontroller%5D=Base](https://www.euramet.org/get/?tx_stag_base%5Bfile%5D=31515&tx_stag_base%5Baction%5D=downloadRaw&tx_stag_base%5Bcontroller%5D=Base)

France	Laboratoire Associé de Débitmétrie Gazeuse (LNE-LADG)	LNE-LADG 43 route de l'Aérodrome 86000 POTIERS FRANCE	<a href="mailto:c.windenberger@ces-ame-exadebit.fr">c.windenberger@ces-ame-exadebit.fr</a> +33 5 49 37 91 26	1.10.- 22.10. 2019	Christophe Windenberger
Czech Republic (PILOT LAB)	Czech Metrology Institute (CMI)	Czech Metrology Institute Gas Flow Department Prumyslova 455 530 03 Pardubice Czech Republic	<a href="mailto:tvalenta@cmi.cz">tvalenta@cmi.cz</a> +420 466 670 728	22.10.- 12.11. 2019	Tomas Valenta

## 2. Instrument

An axial turbine gas meter (*Fig. 1* and *Fig. 2*) was used for the comparison. The description of this meter is mentioned down.

Manufacturer: ELSTER AG Mainz Germany	
EEC type approval: $\text{E D77/721105}$	$P_{\max} : 10 \text{ bar}$
Size: G6500	Inside diameter: DN 400
Serial number: 83001411	Pulse number: $371.20 \text{ imp/m}^3$
$Q_{\min} : 1000 \text{ m}^3/\text{h}$	$Q_{\max} : 10000 \text{ m}^3/\text{h}$
Weight: approximately 400 kg	
Maximum pressure loss in $Q_{\max}$ with air ( $\rho=1.2 \text{ kg/m}^3$ ) : 1200 Pa	



*Figure 1 – Axial turbine gas meter ELSTER G6500*

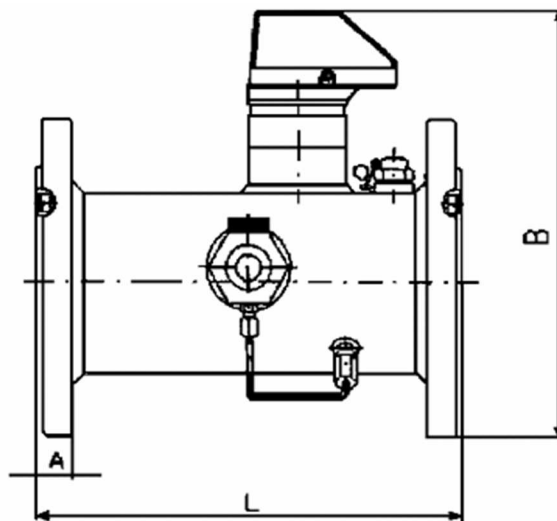

*Figure 2 – Axial turbine gas meter ELSTER G6500*

The dimensions of the meter are mentioned in *table 2* and in the *figure 3*.

*Table 2 - Dimensions of the meter*

L	A	B
1200 mm	45 mm	650 mm



*Figure 3 - Dimensions of the meter*

The high frequency pulse emitter A1S was used. This emitter A1S is made according to DIN EN 50227 (NAMUR). The pulse emitter is mentioned in the *figure 4*.

Operating data of the A1S pulse emitter:  
Supply voltage  $U_n = 8 \text{ V DC}$

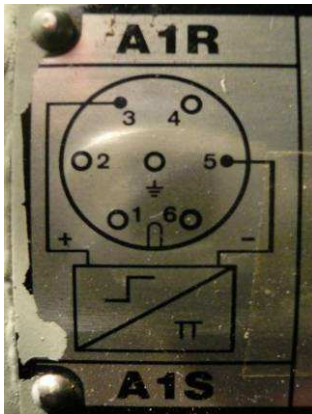

*Figure 4 – Pulse emitter A1S*

The meter was packed in a wooden box that is mentioned in the *figure 5*. The diameter of the box was (1530 x 970 x 840) mm. The weight of the complete box with the meter was approximately 500 kg. In the wooden box there the gas meter was fastened with two textile slings with ratchets (*figure 6*).



Figure 5 – The wooden box for the turbine gas meter G6500



Figure 6 – Textile slings with ratchets

In the box there were the meter, chocks, textile slings with ratchets, a pulse emitter connector and the copy of a technical protocol.

### 3. Calibration procedure

The turbine gas meter G6500 was tested with air in the pressure which is close to barometric pressure. The meter was tested in horizontal position in each laboratory. For the tests it was necessary to use the upstream straightening pipe that was long at least 5x DN and the downstream straightening pipe that was long at least 3x DN. The reference pressure from the turbine gas meter was measured from the output “p<sub>r</sub>”. The reference temperature from the turbine gas meter was measured in the distance (2÷3) x DN downstream of the turbine gas meter.

The pulse emitter AIS with the pulse number 371.20 pulses/m<sup>3</sup> was used for the tests. The calibration had to be performed in the laboratory where the temperature was from 19.5°C to 23.5°C. No oil lubrication was used.

The turbine gas meter was tested in 8 flow rates:  
10000 m<sup>3</sup>/h, 8000 m<sup>3</sup>/h, 6500 m<sup>3</sup>/h, 5000 m<sup>3</sup>/h, 4000 m<sup>3</sup>/h, 3000 m<sup>3</sup>/h, 2000 m<sup>3</sup>/h, 1000 m<sup>3</sup>/h.

The test was repeated at least 3 times in each flow rate and then the means of values in the *table 3* mentioned down were calculated. The flow rate had to be in the interval ± 3% of the required value.

Flow rate in the meter	Absolute pressure in the meter	Temperature in the meter	Pressure loss of the meter	Error of the meter	Uncertainty of the error U(k=2)
(m <sup>3</sup> /h)	(Pa)	(°C)	(Pa)	(%)	(%)
10000					
8000					
6500					
5000					
4000					
3000					
2000					
1000					

**Table 3 - Required table of results**

**Error of the meter** is value which shows the relationship in percentage terms of the difference between the volume indicated by the meter and the volume which has actually flowed through the meter, to the later value.

$$E = \frac{V_i - V_c}{V_c} \cdot 100 \quad (\%) \quad [1]$$

where  $E$  is the error of the meter  
 $V_i$  is the indicated volume by the meter (m<sup>3</sup>)  
 $V_c$  is the real volume which has actually flowed through the meter (m<sup>3</sup>)

## 4. Test facility and obtained results

### 4.1. Czech Republic

**Place of calibration:** Czech Metrology Institute (CMI)  
 Gas Flow Laboratory  
 Průmyslová 455  
 53003 Pardubice  
 Czech Republic

**The test bench (Fig. 15) consists of 3 standard meters:**

- turbine gas meter G4000 ELSTER s.n. 8311878 calibrated in PTB (Germany) every 5 years in the range (1000-10000) m<sup>3</sup>/h
- turbine gas meter G1000 ELSTER s.n. 83012128 calibrated in PTB (Germany) every 5 years in the range (160-1600) m<sup>3</sup>/h



- rotary piston gas meter G250 DELTA S3 FLOW ITRON s.n. 3403657029 calibrated in CMI (Czech republic) every 2 years in the range (8-315) m<sup>3</sup>/h

The air is sucked from air conditioned laboratory through the meter under test and then through the standard meter. During a test only one standard meter is used. After the temperature stabilisation and after the stabilisation of flow rate the calibration of the meter under test can start. The lowest time of test is 60 seconds if HF pulse emitters are used.

In the laboratory the barometric pressure is measured. The values of temperatures in tapings, which are situated 2xDN downstream of the meters, are measured once a second, too. The values of negative pressures are measured by liquid pressure meter. The 5 complete electronic chains with the temperature sensors Pt100 are regularly calibrated every 2 years by CMI. The liquid pressure meters are calibrated regularly by CMI every 4 years.



*Fig. 15 Test facility in CMI*

### Results of Czech Republic:

Flow rate in the meter	Absolute pressure in the meter	Temperature in the meter	Pressure loss of the meter	Error of the meter	Uncertainty of the error U (k=2)
[m <sup>3</sup> /h]	[Pa]	[°C]	[Pa]	[%]	[%]
10000	97327	22.6	887	-0.01	0.19
8000	98273	22.7	581	0.09	0.19
6500	97907	22.5	580	0.10	0.19
5000	98564	22.3	242	0.05	0.19
4000	98720	21.8	154	0.05	0.19
3000	98845	21.4	101	0.03	0.19
2000	98924	21.1	43	-0.01	0.19
1000	98989	20.8	12	0.26	0.19

## 4.2. Denmark

### Description of the test facilities.

The tests were performed on facility FORCE no. C02-003 (in the flow range 1000-4000 m<sup>3</sup>/h), and C02-004 (in the flow range of 4000-10000 m<sup>3</sup>/h) respectively.

The **C02-003** gas flow meter test facility at Force technology, conducts first time verification, control, and recalibration of volume flow meters using atmospheric air in the flow range of 5-4000m<sup>3</sup>/h. It consists of four parallel running test lines (containing reference meters/working standards) in series with 1 primary line, where the meter under test is situated. The necessary working standards are permanently placed in their corresponding test lines, which are chosen according to flow requirements.

The working principle of the facility is that of the suction pressure principle, where atmospheric air from the test laboratory is drawn through the meter under test, (which is placed upstream, before the working standards) and later through the test line further downstream, where the working standards are placed.

The **C02-004** gas flow meter test facility at Force technology, conducts first time verification, control, and recalibration of volume flow meters using atmospheric air in the flow range of 65-25000m<sup>3</sup>/h. The facility consists of five parallel reference lines, and a measuring line in series with these, where the meter under test is located. The facility operates according to the suction pressure principle under atmospheric pressure conditions, where two centrifugal blowers draws air from the calibration room, through the meter under test, and then through the reference strings containing the working standards further downstream.

**Test description:**

During the tests at the two facilities, the meter was placed before the Working standards upstream. The air is drawn through the meter under test and the Working meters after the initial conditioning according to specified requirements.

The pressure differentials were measured by a differential pressure meter between the meter under test, and the Working standards, and between the meter under test and the barometer reading from the test facility. The pressures were measured at the Pr during the tests, for both the meter and Working meters. The corresponding temperature for the meter under test was measured 3D downstream using a thermistor. The absolute pressure differential across the meter was obtained by two pressure tappings, situated 1D upstream and 1D downstream from the meter, respectively. The pressure measurement was made using a Beamex MC6 – A75032.

The maximum used working standards in parallel under test was up to 2 (at 10000 m<sup>3</sup>/h).

**Results of Denmark:**

Flow rate in the meter	Absolute pressure in the meter	Temperature in the meter	Pressure loss of the meter	Error of the meter	Uncertainty of the error U(k=2)
(m <sup>3</sup> /h)	(Pa)	(°C)	(Pa)	(%)	(%)
10000	99472	22.67	911	0.15	0.23
8000	100100	22.82	600	0.18	0.23
6500	100511	23.37	385	0.25	0.23
5000	100770	22.96	233	0.22	0.23
4000	101424	20.31	135	0.19	0.24
3000	101465	20.34	87	0.17	0.25
2000	101506	20.34	46	0.15	0.24
1000	101570	20.24	9	0.32	0.24

**Traceability:**

The Working standards are traceable to the VSL in Holland, are being recalibrated every year. The thermistor is traceable to NPL in England, and the pressure meters are traceable to PTB in Germany.

**Uncertainty:**

The Uncertainty of the calibration is in accordance with EA-4/02 “Expression of the Uncertainty of Measurement in Calibration”, and is the following for each test facility:

C02-003:  
(400-4000m<sup>3</sup>/h)  $U_{tot} \pm 0,24$  [%]

C02-004:  
(65-25000m<sup>3</sup>/h)  $U_{tot} \pm 0,23$  [%]

### 4.3. France

The pressure test bench (*Fig. 7*) for medium and high flow rates at Poitiers can generate flow rates from 8 m<sup>3</sup>/h to 90000m<sup>3</sup>/h (standard conditions). A set of 12 Venturi nozzles (nominal flow rate: 1.5 to 1000 m<sup>3</sup>.h<sup>-1</sup>.bar<sup>-1</sup>) operating in sonic conditions is used for the determination of the standard mass flow rate. The longest testing pipeline is 50 m long with nominal diameters from DN25 up to DN300. The test pressure range is from 1 bar up to 50 bar (absolute). Compressed dry air stored in a 110 m<sup>3</sup> vessel under 200 bar is used as the test fluid. Possibilities of testing pressure from 50 to 150 bar are also available on request.

The meter under test is placed on a pipeline downstream the set of nozzles. This configuration allows a comparison between the reference and tested device mass flows. The pressure and the temperature can be measured at the level of the meter in test in order to determine the volumetric flow rate going through.

The air coming from a storage vessel (200 bar-110 m<sup>3</sup>) goes through the valves and the heating control system. This adjusts the suitable temperature and pressure upstream the nozzles automatically. The pipe lines bear the reference nozzles chosen according to the flow patterns to be generated for the tests.

These nozzles are traceable to National Standards since they are calibrated with the GDF "Pisc" facility (PVT, time method). In addition, nozzles for flow, pressures determination are measured using Desgranges & Huot weight testers and temperatures are measured using PT100 and thermocouples probes. All the instruments and probes used are traceable to national standards (LNE for pressure and temperature, LCIE for Voltage).

#### Procedure

- The test line comprises a upstream straight length greater than 20D and the downstream straight length greater than 10D
- The temperature was close to room temperature (20±5)°C
- The tests were performed at flow rates in the range of 10 % to 100 % of the maximum flow rate and under an absolute pressure close to 1 bar
- Calculation of the Reynolds number was performed according to an formula

$$Re = \frac{\rho V D}{\mu}$$

where  $\mu$  is dynamic viscosity which is determined by the Sutherland equation

$$\mu = \mu_0 \sqrt{(T_c/273,15)} \cdot \frac{1 + \frac{120}{273,15}}{1 + \frac{120}{T_c}}$$

$$\mu_0 = 170,8 \cdot 10^{-7} \text{ Pa}\cdot\text{s}$$

where  $T_c$  is the temperature of the air measured downstream from the meter at around 2D.

**Figure 10 – Test bench in Poitiers**

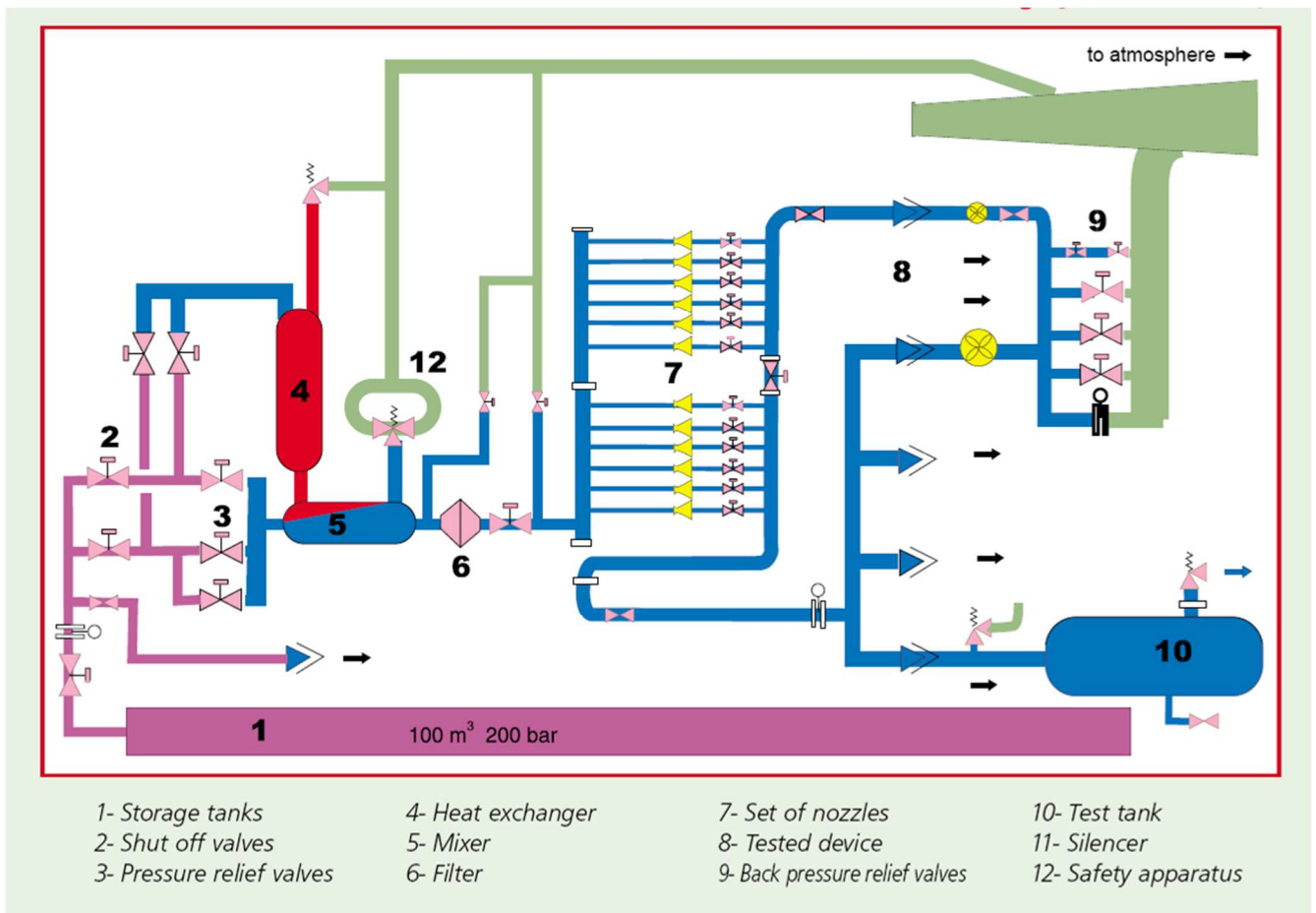

Place of calibration: CESAME LNE ouest - 43, route de l'aérodrome - F - 86036 Poitiers  
Cedex

### Results of France:

Flow rate	Absolute pressure	Absolute pressure	Temperature	Reynolds Number	Error of the meter	Uncertainty of the error
m <sup>3</sup> /h	bar	Pa	°C		%	%
9929.0	1.0632	106318	13.55	6.387E+05	0.05	0.21
8067.3	1.0430	104302	13.13	5.104E+05	0.13	0.21
6476.6	1.0302	103023	12.74	4.058E+05	0.11	0.21
5028.1	1.0093	100929	14.34	3.055E+05	0.14	0.21
3917.7	1.0034	100341	11.60	2.408E+05	0.12	0.21
3013.2	1.0005	100049	12.92	1.831E+05	0.08	0.21
2016.1	0.9981	99811	13.28	1.220E+05	0.04	0.21
1008.2	1.0091	100913	13.64	6.152E+04	0.00	0.21

## 5. Stability of the meter and the dependency of laboratories

During the project the turbine gas meter was tested three times in the pilot laboratory (CMI). Obtained results are mentioned down.

flow rate (m <sup>3</sup> /h)	error of the meter 4.6.2019	error of the meter 28.8.2019	error of the meter 14.11.2019	maximum difference
(m <sup>3</sup> /h)	(%)	(%)	(%)	(%)
10000	-0.01	-0.01	-0.07	0.06
8000	0.08	0.09	0.02	0.07
6500	0.11	0.10	0.05	0.06
5000	0.09	0.05	0.01	0.08
4000	0.07	0.05	0.02	0.05
3000	0.03	0.03	0.02	0.01
2000	0.00	-0.01	-0.01	0.01
1000	0.27	0.26	0.23	0.04

The estimated standard uncertainty caused by the stability (reproducibility) of the turbine meter is approximately  $u_{tm}=0.023$  %. In this case the uniform distribution between minimal value and maximal value is assumed.

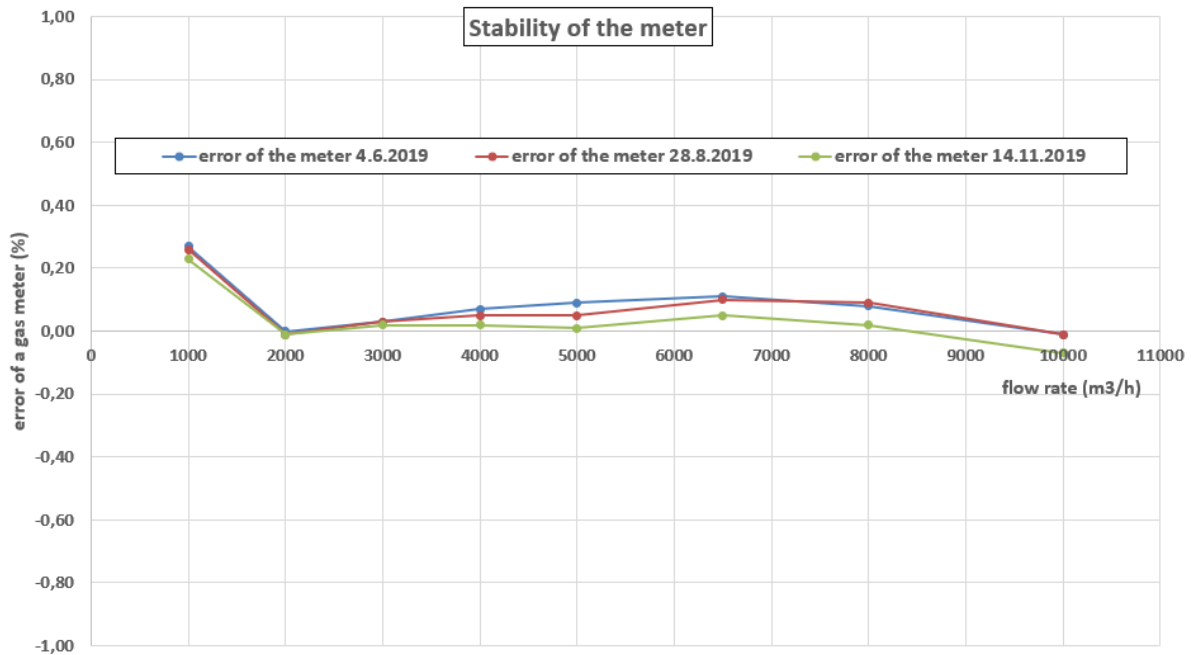

In this project there was 1 independent laboratory:  
France

In this project there was 1 laboratory traceable to Netherlands (VSL):  
Denmark

In this project there was 1 laboratory traceable to Germany (PTB):  
Czech Republic

## 6. Determination of the reference values in determined flow rates

### 6.1. Description of the method

The reference value was determined in each flow rate separately. The method of determination of the reference value in each flow rate corresponds to the procedure A presented by M.G.Cox<sup>2)</sup>. Only results from independent laboratories were taken into account for the determination of the key comparison reference value (KCRV) and of the uncertainty of the key comparison reference value. Then the results from dependent laboratories were

<sup>2)</sup> Cox M.G., *Evaluation of key comparison data*, Metrologia, 2002, **39**, 589-595

compared with the key comparison reference value and with the uncertainty of the key comparison reference value.

### 6.1.1. The determination of the Key Comparison Reference Value (KCRV) and its uncertainty

The reference value  $y$  was calculated as weighted mean error (WME):

$$y = \frac{\frac{x_1}{u_{x1}^2} + \frac{x_2}{u_{x2}^2} + \dots + \frac{x_n}{u_{xn}^2}}{\frac{1}{u_{x1}^2} + \frac{1}{u_{x2}^2} + \dots + \frac{1}{u_{xn}^2}}, \quad [4]$$

where  $x_1, x_2, \dots, x_n$  are errors of the meter in one flow rate in different independent laboratories  $1, 2, \dots, n$   
 $u_{x1}, u_{x2}, \dots, u_{xn}$  are standard uncertainties (not expanded) of the error in different independent laboratories  $1, 2, \dots, n$  including the uncertainty caused by stability of the meter

The standard uncertainties (not expanded) of the error in different laboratories  $u_{x1}, u_{x2}, \dots, u_{xn}$  (equation [4]) include the stability of the meter. These uncertainties were calculated by

$$u_{xi} = \sqrt{\left(\frac{U_{xi\_lab}}{2}\right)^2 + (u_{tm})^2} \quad [5]$$

where  $U_{xi\_lab}$  is the expanded uncertainty ( $k=2$ ) determined by laboratory  $i$  and presented in results of laboratory  $i$   
 $u_{tm}$  is estimated standard uncertainty caused by the stability (reproducibility) of the turbine gas meter (see chapter 5)

The standard uncertainty of the reference value  $u_y$  is given by

$$\frac{1}{u_y^2} = \frac{1}{u_{x1}^2} + \frac{1}{u_{x2}^2} + \dots + \frac{1}{u_{xn}^2} \quad [6]$$

The expanded uncertainty of the reference value  $U(y)$  is

$$U(y) = 2 \cdot u_y \quad [7]$$

The chi-squared test for consistency check was performed using values of errors of the meter in each flow rate. At first the chi-squared value  $\chi_{obs}^2$  was calculated by



$$\chi_{obs}^2 = \frac{(x_1 - y)^2}{u_{x1}^2} + \frac{(x_2 - y)^2}{u_{x2}^2} + \dots + \frac{(x_n - y)^2}{u_{xn}^2} \quad [8]$$

The degrees of freedom  $\nu$  were assigned

$$\nu = n - 1 \quad [9]$$

where  $n$  is number of evaluated laboratories.

The consistency check was failing if

$$Pr\{ \chi_{\nu}^2 > \chi_{obs}^2 \} < 0,05 \quad [10]$$

(The function  $CHIINV(0,05; \nu)$  in MS Excel was used. The consistency check was failing if  $CHIINV(0,05; \nu) < \chi_{obs}^2$ )

If the consistency check did not fail then  $y$  was accepted as the key comparison reference value  $x_{ref}$  and  $U(y)$  was accepted as the expanded uncertainty of the key comparison reference value  $U(x_{ref})$ .

If the consistency check failed then the laboratory with the highest value of  $\frac{(x_i - y)^2}{u_{xi}^2}$  was excluded for the next round of evaluation and the new reference value  $y$  (WME), the new standard uncertainty of the reference value  $u_y$  and the chi-squared value  $\chi_{obs}^2$  were calculated again without the values of excluded laboratory. The consistency check was calculated again, too. This procedure was repeated till the consistency check passed.

### 6.1.2. The determination of the differences "Lab to KCRV" as well as their uncertainties and Degrees of Equivalence

When the KCRV was determined, the differences between the participating laboratories and the KCRV were calculated according to

$$di = x_i - x_{ref} \quad [11]$$

Based on these differences, the **Degree of Equivalence** ( $DoE$ ) was calculated according to:

$$Ei = \left| \frac{di}{U(di)} \right| \quad [12]$$

The  $DoE$  is a measure for the equivalence of the results of any laboratory with the KCRV or with any other laboratory, respectively:

- The results of a laboratory is **equivalent (passed)** if  $Ei \leq 1$ .
- The laboratory was determined as **not equivalent (failed)** if  $Ei > 1.2$ .

- For values of  $DoE$  in the range  $1 < Ei \leq 1.2$  we define “warning level” were actions to check is recommended to the laboratory.

The reason for such “warning level” is that we have to consider the confidence in the determination of the uncertainties (for the results of labs as well the KCRV). Conventionally we work at a 95% confidence level. Therefore in some comparisons a range up to  $E < 1.5$  is used for these “warnings”<sup>4)</sup>. This is a reasonable value where stochastic influences dominate the uncertainty budgets. In the case of comparisons for gas flow, the smaller value 1.2 was chosen, which reflects the dominance of non-stochastic parts of uncertainty compared to the stochastic parts. (The reproducibility is usually much better than the total uncertainty of a laboratory).<sup>5)</sup>

## 6.2. Flow rate 10000 m<sup>3</sup>/h

### The first and last round of evaluation in 10000 m<sup>3</sup>/h:

Country	Error of the meter $x$	Uncertainty $U(k=2)$	Uncertainty +stability $U(k=2)$	$\frac{(x_i - y)^2}{\left(\frac{U(x_i)}{2}\right)^2}$	$1/u^2$	$x*(1/u)^2$
	(%)	(%)	(%)			
Czech Republic	-0.01	0.19	0.19549	0.425	104.67	-1.05
Denmark	0.15	0.23	0.23455	0.674	72.71	10.91
France	0.05	0.21	0.21498	0.001	86.55	4.33

$$WME = y = 0.0538$$

$$U(y) = 0.1231$$

$$CHIINV = 5.9915$$

$$\chi_{obs}^2 = 1.1001$$

The consistency check passed because  $CHIINV > \chi_{obs}^2$

<sup>4)</sup> C. Ullner et al., *Special features in proficiency tests of mechanical testing laboratories*, and P. Robouch et al., *The „Naji Plot“, a simple graphical tool for the evaluation of inter-laboratory comparisons*,

Both in: D. Richter, W. Wöger, W. Hässelbarth (ed.) *Data analysis of key comparisons*, 178. PTB-Seminar/International Workshop, ISBN 3-89701-933-3.

<sup>5)</sup> D.Doppeide, B.Mickan, R.Kramer, H.-J.Hotze, J.-P.Vallet, M.R.Harris, Jiunn-Haur Shaw, Kyung-Am Park, *CIPM Key Comparisons for Compressed Air and Nitrogen, CCM.FF-5.b – Final Report*, 07/09/2006  
[http://kcdb.bipm.org/appendixB/appbresults/ccm.ff-k5.b/ccm.ff-k5.b\\_final\\_report.pdf](http://kcdb.bipm.org/appendixB/appbresults/ccm.ff-k5.b/ccm.ff-k5.b_final_report.pdf)

Country	Error of the meter $x$	Uncertainty $U(k=2)$	Uncertainty +stability $U(k=2)$	$d_i$	$U(d_i)$	$E_i$
	(%)	(%)	(%)	(%)		
Czech Republic	-0.01	0.19	0.19549	-0.06	0.152	0.42
Denmark	0.15	0.23	0.23455	0.10	0.200	0.48
France	0.05	0.21	0.21498	0.00	0.176	0.02

Euramet no.1469, flow rate 10000 m<sup>3</sup>/h

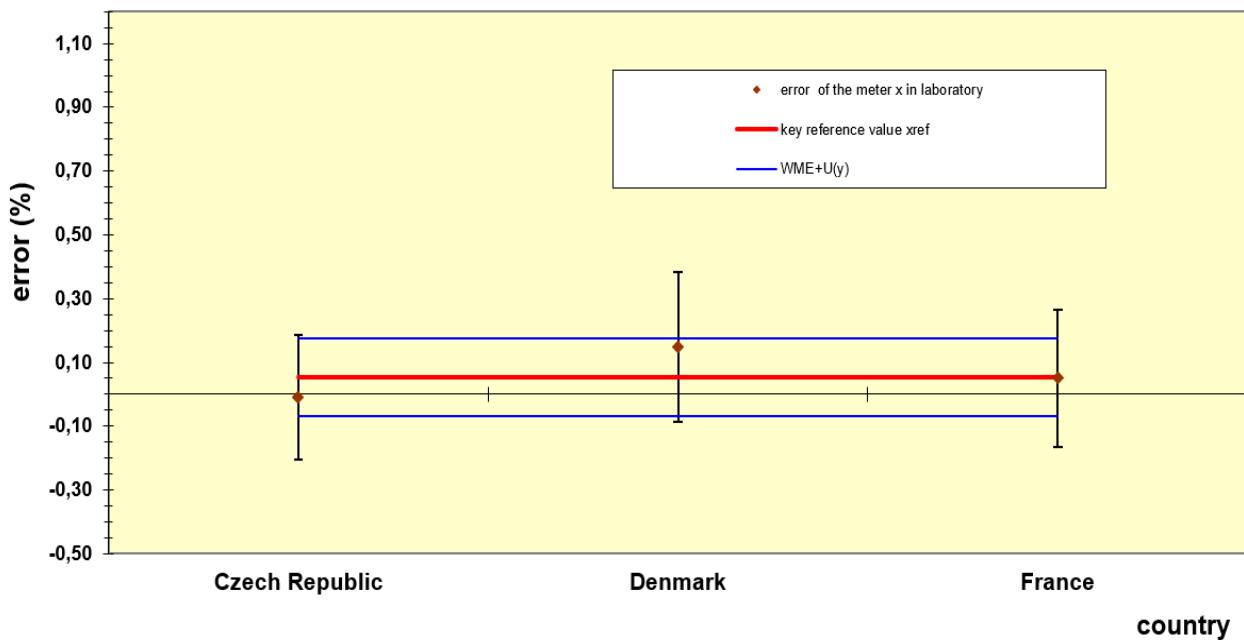

### 6.3. Flow rate 8000 m<sup>3</sup>/h

The first and last round of evaluation in 8000 m<sup>3</sup>/h:

Country	Error of the meter $x$	Uncertainty $U(k=2)$	Uncertainty +stability $U(k=2)$	$\frac{(x_i - y)^2}{\left(\frac{U(x_i)}{2}\right)^2}$	$1/u^2$	$x^*(1/u)^2$
	(%)	(%)	(%)			
Czech Republic	0.09	0.19	0.19549	0.150	104.67	9.42
Denmark	0.18	0.23	0.23455	0.197	72.71	13.09
France	0.13	0.21	0.21498	0.000	86.55	11.25

$$\begin{aligned} \text{WME} = y &= 0.1279 \\ U(y) &= 0.1231 \\ \text{CHIINV} &= 5.9915 \\ \chi_{obs}^2 &= 0.3481 \end{aligned}$$

The consistency check passed because  $\text{CHIINV} > \chi_{obs}^2$

Country	Error of the meter $x$	Uncertainty $U(k=2)$	Uncertainty +stability $U(k=2)$	$d_i$	$U(d_i)$	$E_i$
	(%)	(%)	(%)	(%)		
Czech Republic	0.09	0.19	0.19549	-0.04	0.152	0.25
Denmark	0.18	0.23	0.23455	0.05	0.200	0.26
France	0.13	0.21	0.21498	0.00	0.176	0.01

Euramet no.1469, flow rate 8000 m<sup>3</sup>/h

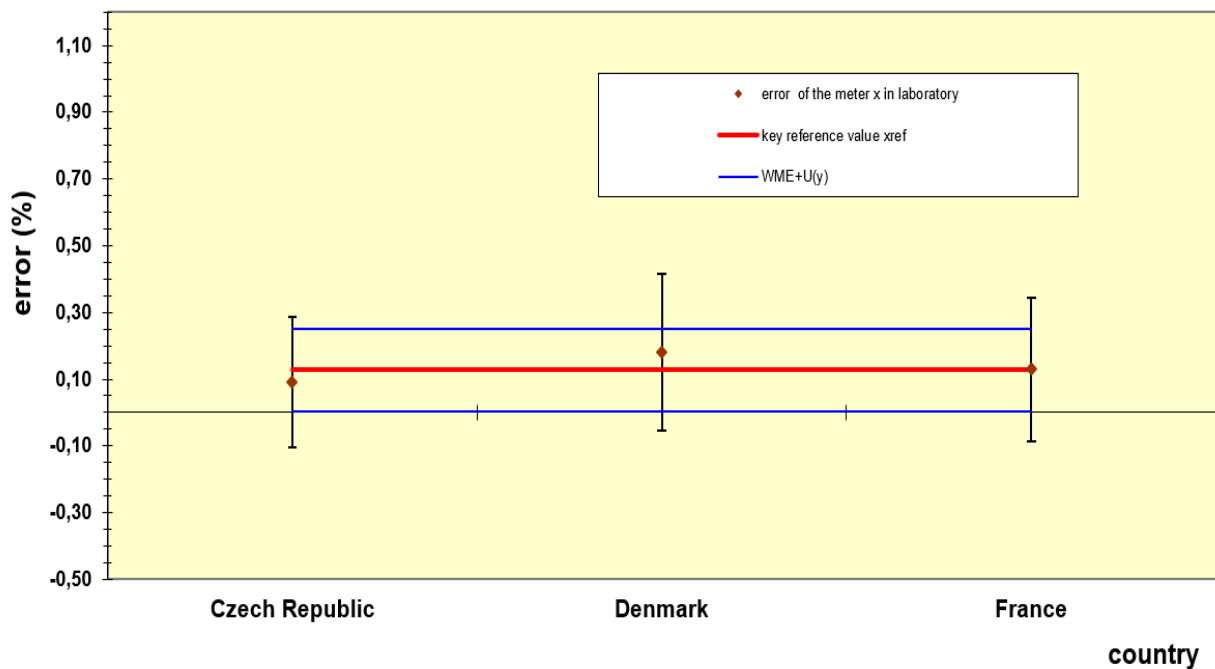

#### 6.4. Flow rate 6500 m<sup>3</sup>/h

The first and last round of evaluation in 6500 m<sup>3</sup>/h:



Country	Error of the meter $x$	Uncertainty $U(k=2)$	Uncertainty +stability $U(k=2)$	$\frac{(x_i - y)^2}{\left(\frac{U(x_i)}{2}\right)^2}$	$1/u^2$	$x*(1/u)^2$
	(%)	(%)	(%)			
Czech Republic	0.10	0.19	0.19549	0.208	104.67	10.47
Denmark	0.25	0.23	0.23455	0.808	72.71	18.18
France	0.11	0.21	0.21498	0.104	86.55	9.52

WME =  $y = 0.1446$

$U(y) = 0.1231$

CHIINV = 5.9915

$\chi_{obs}^2 = 1.1195$

The consistency check passed because  $CHIINV > \chi_{obs}^2$

Country	Error of the meter $x$	Uncertainty $U(k=2)$	Uncertainty +stability $U(k=2)$	$d_i$	$U(d_i)$	$E_i$
	(%)	(%)	(%)	(%)		
Czech Republic	0.10	0.19	0.19549	-0.04	0.152	0.29
Denmark	0.25	0.23	0.23455	0.11	0.200	0.53
France	0.11	0.21	0.21498	-0.03	0.176	0.20

Euramet no.1469, flow rate 6500 m<sup>3</sup>/h

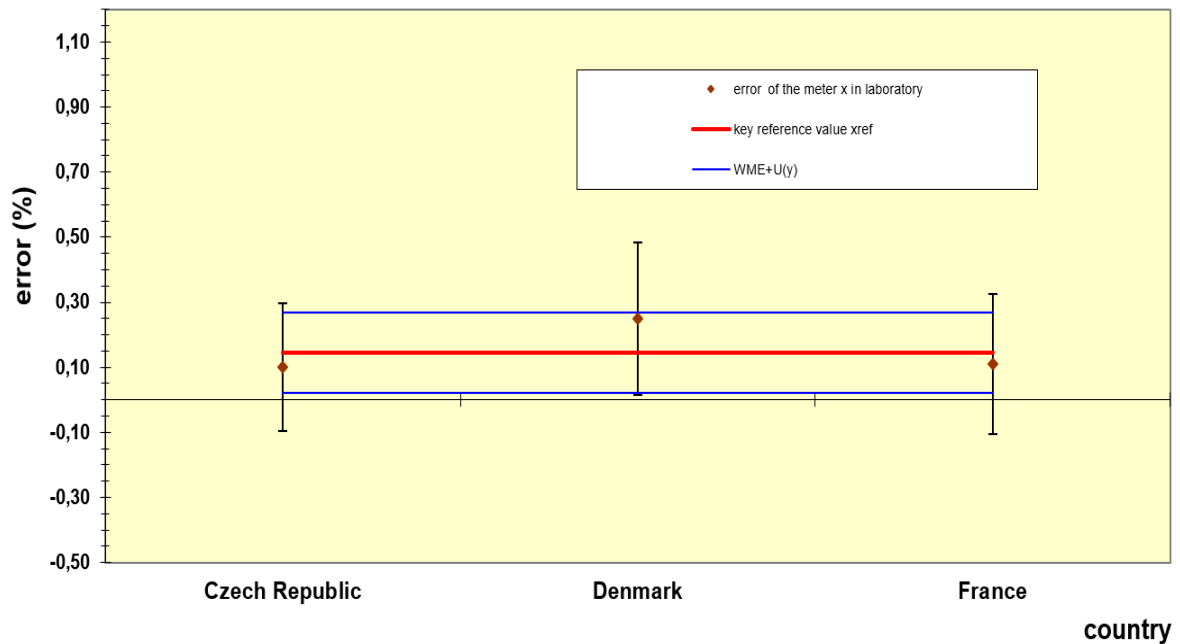

## 6.5. Flow rate 5000 m<sup>3</sup>/h

The first and last round of evaluation in 5000 m<sup>3</sup>/h:

Country	Error of the meter $x$	Uncertainty $U(k=2)$	Uncertainty +stability $U(k=2)$	$\frac{(x_i - y)^2}{\left(\frac{U(x_i)}{2}\right)^2}$	$1/u^2$	$x^*(1/u)^2$
				(%)		
Czech Republic	0.05	0.19	0.19549	0.610	104.67	5.23
Denmark	0.22	0.23	0.23455	0.638	72.71	16.00
France	0.14	0.21	0.21498	0.016	86.55	12.12

$$WME = y = 0.1263$$

$$U(y) = 0.1231$$

$$CHIINV = 5.9915$$

$$\chi_{obs}^2 = 1.2639$$

The consistency check passed because  $CHIINV > \chi_{obs}^2$

Country	Error of the meter $x$	Uncertainty $U(k=2)$	Uncertainty +stability $U(k=2)$	$d_i$	$U(d_i)$	$E_i$
	(%)	(%)	(%)	(%)		
Czech Republic	0.05	0.19	0.19549	-0.08	0.152	0.50
Denmark	0.22	0.23	0.23455	0.09	0.200	0.47
France	0.14	0.21	0.21498	0.01	0.176	0.08

Euramet no.1469, flow rate 5000 m<sup>3</sup>/h

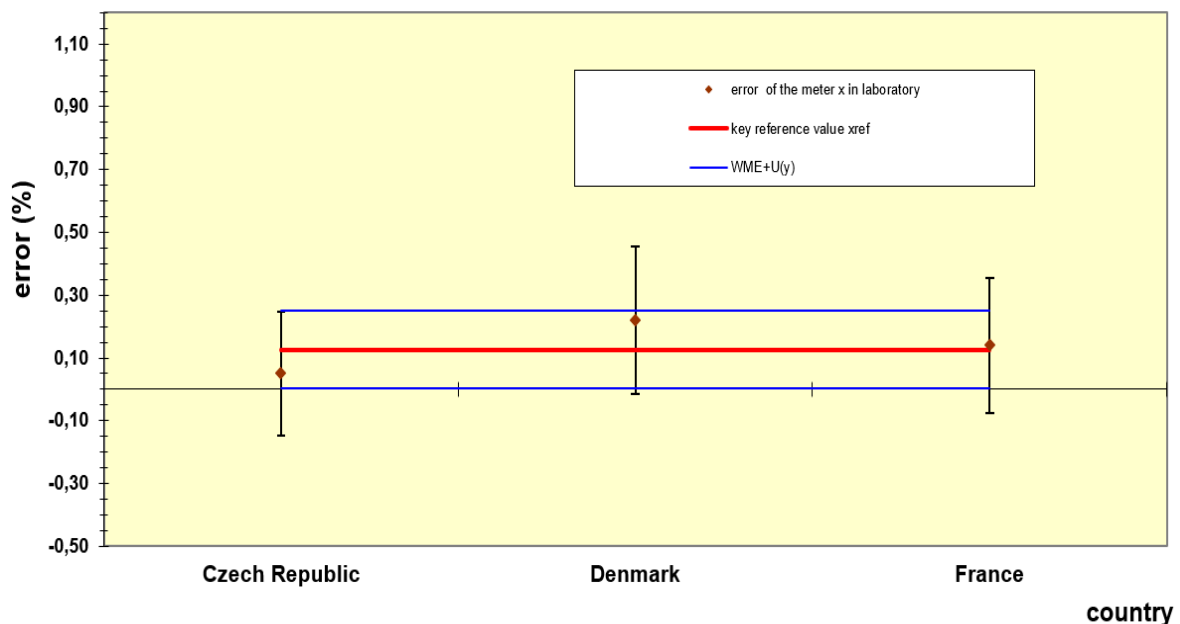

## 6.6. Flow rate 4000 m<sup>3</sup>/h

The first and last round of evaluation in 4000 m<sup>3</sup>/h:

Country	Error of the meter $x$	Uncertainty $U(k=2)$	Uncertainty +stability $U(k=2)$	$\frac{(x_i - y)^2}{\left(\frac{U(x_i)}{2}\right)^2}$	$1/u^2$	$x^*(1/u)^2$
				(%)		
Czech Republic	0.05	0.19	0.19549	0.374	104.67	5.23
Denmark	0.19	0.24	0.24437	0.431	66.98	12.73
France	0.12	0.21	0.21498	0.009	86.55	10.39

$$\begin{aligned} \text{WME} = y &= 0.1098 \\ U(y) &= 0.1245 \\ \text{CHIINV} &= 5.9915 \\ \chi_{obs}^2 &= 0.8141 \end{aligned}$$

The consistency check passed because  $\text{CHIINV} > \chi_{obs}^2$

Country	Error of the meter $x$	Uncertainty $U(k=2)$	Uncertainty +stability $U(k=2)$	$d_i$	$U(d_i)$	$E_i$
	(%)	(%)	(%)	(%)		
Czech Republic	0.05	0.19	0.19549	-0.08	0.152	0.50
Denmark	0.22	0.23	0.23455	0.09	0.200	0.47
France	0.14	0.21	0.21498	0.01	0.176	0.08

Euramet no.1469, flow rate 4000 m<sup>3</sup>/h

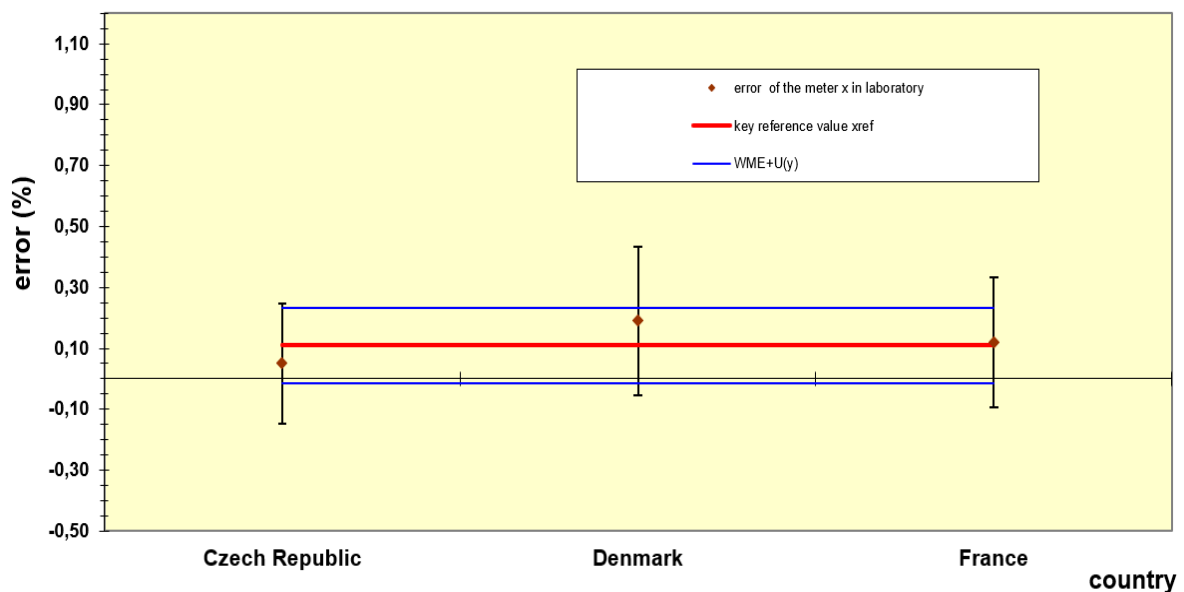

## 6.7. Flow rate 3000 m<sup>3</sup>/h

The first and last round of evaluation in 3000 m<sup>3</sup>/h:

Country	Error of the meter $x$	Uncertainty $U(k=2)$	Uncertainty +stability $U(k=2)$	$\frac{(x_i - y)^2}{\left(\frac{U(x_i)}{2}\right)^2}$	$1/u^2$	$x^*(1/u)^2$
	(%)	(%)	(%)			
Czech Republic	0.03	0.19	0.19549	0.276	104.67	3.14
Denmark	0.17	0.25	0.25420	0.487	61.90	10.52
France	0.08	0.21	0.21498	0.000	86.55	6.92

$$WME = y = 0.0813$$

$$U(y) = 0.1257$$

$$CHIINV = 5.9915$$

$$\chi_{obs}^2 = 0.7626$$

The consistency check passed because  $CHIINV > \chi_{obs}^2$

Country	Error of the meter $x$	Uncertainty $U(k=2)$	Uncertainty +stability $U(k=2)$	$d_i$	$U(d_i)$	$E_i$
	(%)	(%)	(%)	(%)		
Czech Republic	0.03	0.19	0.19549	-0.05	0.150	0.34
Denmark	0.17	0.25	0.25420	0.09	0.221	0.40
France	0.08	0.21	0.21498	0.00	0.174	0.01

Euramet no.1469, flow rate 3000 m<sup>3</sup>/h

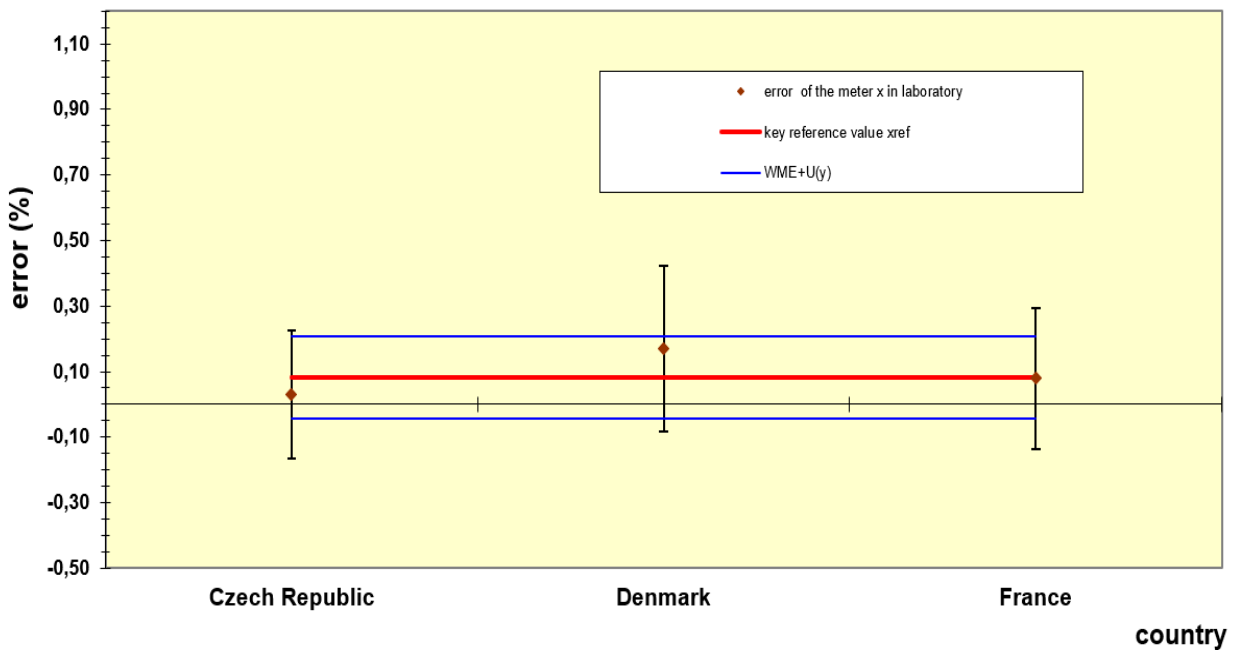



## 6.8. Flow rate 2000 m<sup>3</sup>/h

The first and last round of evaluation in 2000 m<sup>3</sup>/h:

Country	Error of the meter $x$	Uncertainty $U(k=2)$	Uncertainty +stability $U(k=2)$	$\frac{(x_i - y)^2}{\left(\frac{U(x_i)}{2}\right)^2}$	$1/u^2$	$x^*(1/u)^2$
	(%)	(%)	(%)			
Czech Republic	-0.01	0.19	0.19549	0.355	104.67	-1.05
Denmark	0.15	0.24	0.24437	0.693	66.98	10.05
France	0.04	0.21	0.21498	0.006	86.55	3.46

$$WME = y = 0.0483$$

$$U(y) = 0.1245$$

$$CHIINV = 5.9915$$

$$\chi_{obs}^2 = 1.0545$$

The consistency check passed because  $CHIINV > \chi_{obs}^2$

Country	Error of the meter $x$	Uncertainty $U(k=2)$	Uncertainty +stability $U(k=2)$	$d_i$	$U(d_i)$	$E_i$
	(%)	(%)	(%)	(%)		
Czech Republic	-0.01	0.19	0.19549	-0.06	0.151	0.39
Denmark	0.15	0.24	0.24437	0.10	0.210	0.48
France	0.04	0.21	0.21498	-0.01	0.175	0.05

Euramet no.1469, flow rate 2000 m<sup>3</sup>/h

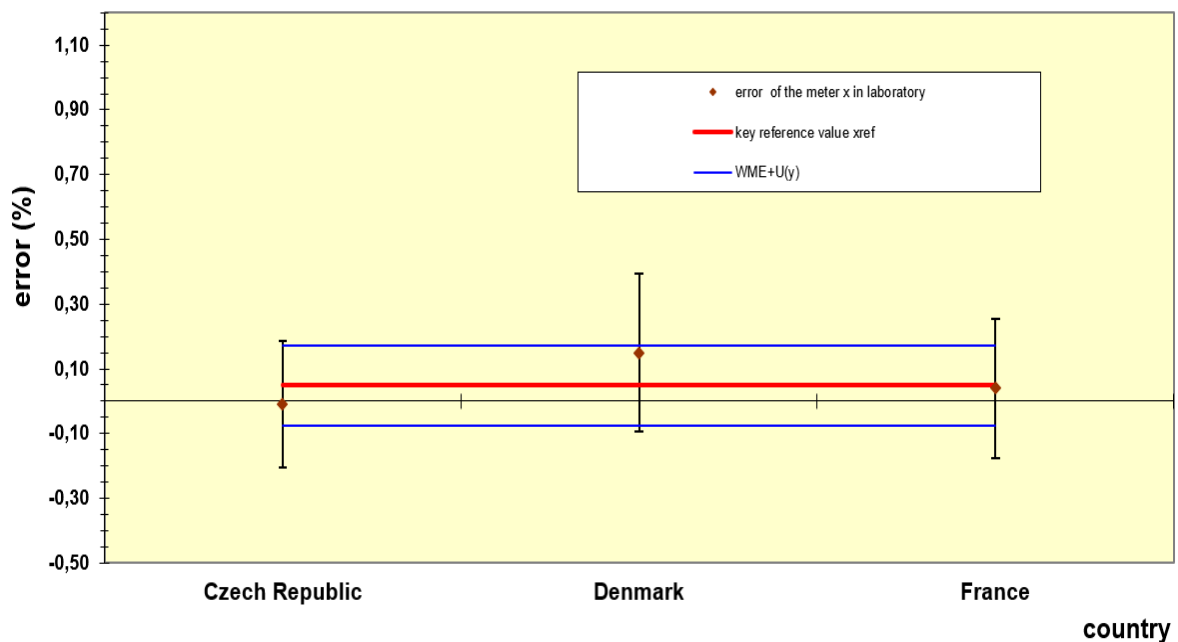

## 6.9. Flow rate 1000 m<sup>3</sup>/h

The first and last round of evaluation in 1000 m<sup>3</sup>/h:

Country	Error of the meter $x$	Uncertainty $U(k=2)$	Uncertainty +stability $U(k=2)$	$\frac{(x_i - y)^2}{\left(\frac{U(x_i)}{2}\right)^2}$	$1/u^2$	$x^*(1/u)^2$
				(%)		
Czech Republic	0.26	0.19	0.19549	0.536	104.67	27.21
Denmark	0.32	0.24	0.24437	1.160	66.98	21.43
France	0.00	0.21	0.21498	3.072	86.55	0.00

$$\begin{aligned} \text{WME} = y &= 0.1884 \\ U(y) &= 0.1245 \\ \text{CHIINV} &= 5.9915 \\ \chi_{obs}^2 &= 4.7687 \end{aligned}$$

The consistency check passed because  $\text{CHIINV} > \chi_{obs}^2$

Country	Error of the meter $x$	Uncertainty $U(k=2)$	Uncertainty +stability $U(k=2)$	$d_i$	$U(d_i)$	$E_i$
	(%)	(%)	(%)	(%)		
Czech Republic	0.26	0.19	0.19549	0.07	0.151	0.47
Denmark	0.32	0.24	0.24437	0.13	0.210	0.63
France	0.00	0.21	0.21498	-0.19	0.175	1.07

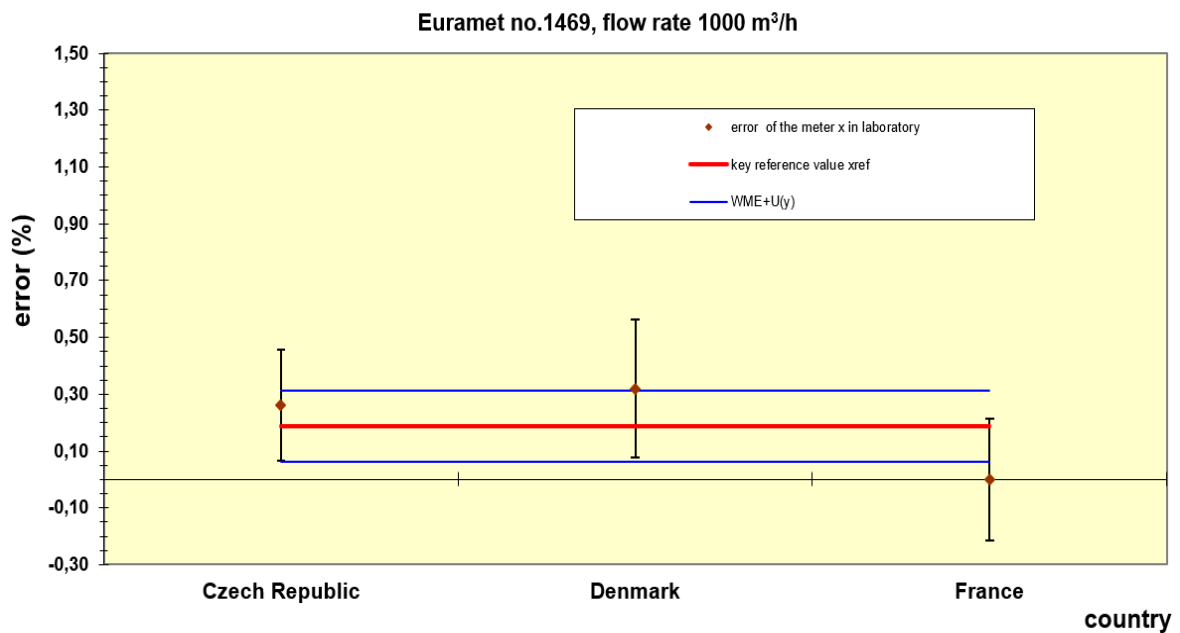

## 7. Results

### 7.1. France - Independent laboratory

flow rate in the meter	error of the meter in laboratory	uncertainty of the error $U(k=2)$	actual uncertainty declared in CMC $U(k=2)$	uncertainty of the error including stability of the meter $U(k=2)$	key reference value $x_{ref}$	expanded uncertainty of the key reference value $U(x_{ref})$	di	Ei	result
m <sup>3</sup> /h	%	%	%	%	%	%	%		
10000	0.05	0.21	0.26	0.21498	0.05	0.12	0.00	0.02	passed
8000	0.13	0.21	0.26	0.21498	0.13	0.12	0.00	0.01	passed
6500	0.11	0.21	0.26	0.21498	0.14	0.12	-0.03	0.20	passed
5000	0.14	0.21	0.26	0.21498	0.13	0.12	0.01	0.08	passed
4000	0.12	0.21	0.26	0.21498	0.11	0.12	0.01	0.06	passed
3000	0.08	0.21	0.26	0.21498	0.08	0.13	0.00	0.01	passed
2000	0.04	0.21	0.26	0.21498	0.05	0.12	-0.01	0.05	passed
1000	0.00	0.21	0.26	0.21498	0.19	0.12	-0.19	1.07	warning
<b>mean</b>							<b>-0.03</b>	<b>0.19</b>	<b>passed</b>

The *uncertainty of the error* is different from the CMC because LNE-LADG (CESAME EXADEBIT) is modifying its CMC this year. All sonic nozzles have been calibrated on the new primary facility which allows to obtain a smaller uncertainty on the secondary test bench.

France - (LNE-LADG [CESAME EXADEBIT]) - Euramet project no. 1469

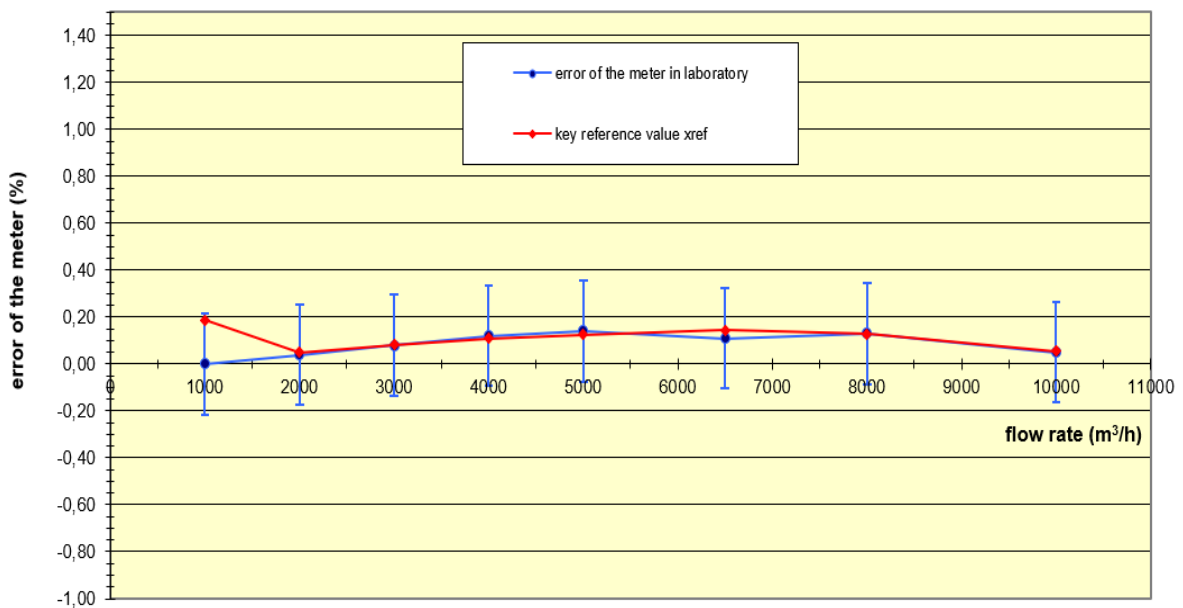

## 7.2. Czech Republic - Dependent laboratory (to PTB)

flow rate in the meter	error of the meter in laboratory	uncertainty of the error $U(k=2)$	actual uncertainty declared in CMC $U(k=2)$	uncertainty of the error including stability of the meter $U(k=2)$	key reference value $x_{ref}$	expanded uncertainty of the key reference value $U(x_{ref})$	di	Ei	result
$m^3/h$	%	%	%	%	%	%	%		
10000	-0.01	0.19	0.19	0.1955	0.05	0.12	-0.06	0.42	passed
8000	0.09	0.19	0.19	0.1955	0.13	0.12	-0.04	0.25	passed
6500	0.10	0.19	0.19	0.1955	0.14	0.12	-0.04	0.29	passed
5000	0.05	0.19	0.19	0.1955	0.13	0.12	-0.08	0.50	passed
4000	0.05	0.19	0.19	0.1955	0.11	0.12	-0.06	0.40	passed
3000	0.03	0.19	0.19	0.1955	0.08	0.13	-0.05	0.34	passed
2000	-0.01	0.19	0.19	0.1955	0.05	0.12	-0.06	0.39	passed
1000	0.26	0.19	0.19	0.1955	0.19	0.12	0.07	0.47	passed
<b>mean</b>							<b>-0.04</b>	<b>0.38</b>	<b>passed</b>

Czech Republic (CMI) - Euramet project no. 1469

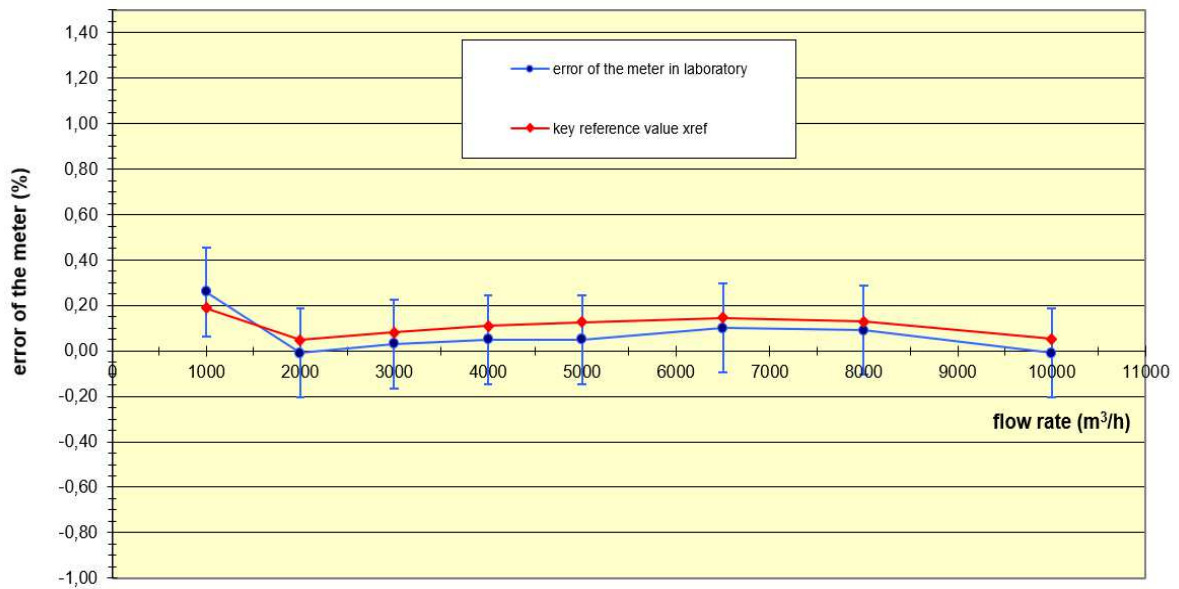

### 7.3. Denmark - Dependent laboratory (to VSL)

flow rate in the meter	error of the meter in laboratory	uncertainty of the error $U(k=2)$	actual uncertainty declared in CMC $U(k=2)$	uncertainty of the error including stability of the meter $U(k=2)$	key reference value $x_{ref}$	expanded uncertainty of the key reference value $U(x_{ref})$	$d_i$	$E_i$	result
$m^3/h$	%	%	%	%	%	%	%		
10000	0.15	0.23	-	0.2346	0.05	0.12	0.10	0.48	passed
8000	0.18	0.23	-	0.2346	0.13	0.12	0.05	0.26	passed
6500	0.25	0.23	-	0.2346	0.14	0.12	0.11	0.53	passed
5000	0.22	0.23	-	0.2346	0.13	0.12	0.09	0.47	passed
4000	0.19	0.24	0.24	0.2444	0.11	0.12	0.08	0.38	passed
3000	0.17	0.25	0.24	0.2542	0.08	0.13	0.09	0.40	passed
2000	0.15	0.24	0.24	0.2444	0.05	0.12	0.10	0.48	passed
1000	0.32	0.24	0.24	0.2444	0.19	0.12	0.13	0.63	passed
<b>mean</b>							<b>0.09</b>	<b>0.45</b>	<b>passed</b>

The uncertainty of the error is different from the CMC because FORCE TECHNOLOGY has used a new test facility for this calibration.

Denmark (FORCE TECHNOLOGY) - Euramet project no. 1469

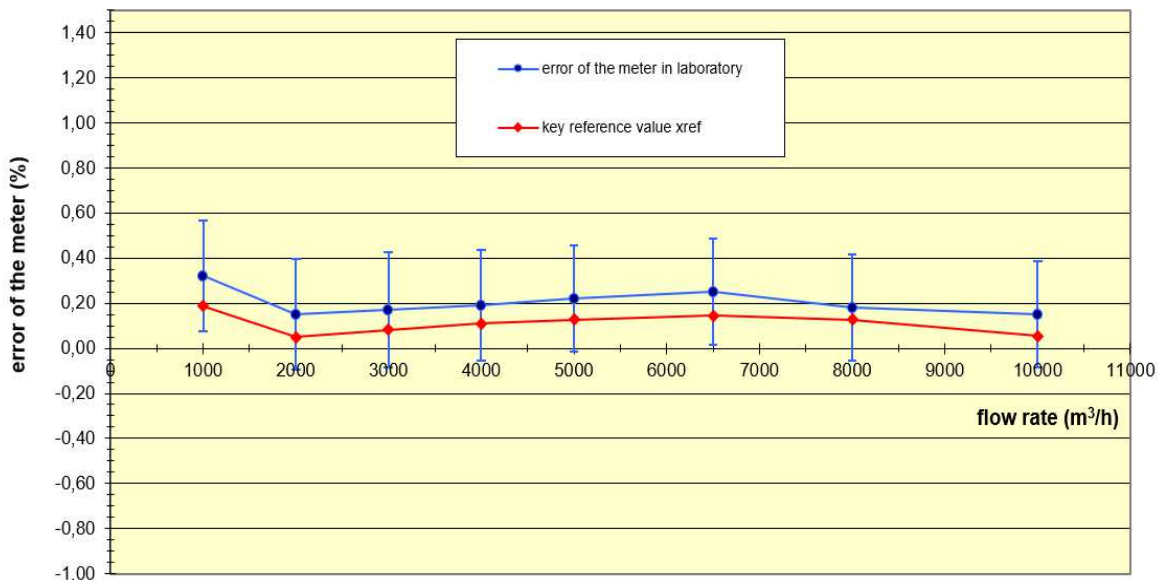

## 8. Summary and conclusion

The summary of results is mentioned down in the *table 4*. The independent laboratories are **light green**. The laboratories with traceability to Germany (PTB) are **light yellow**. The laboratories with traceability to Netherlands (VSL) are **light blue**. **The colour of letters is red if there is the evaluation “failed” in tables. The colour of letters is light orange if there is the evaluation “warning level” in tables.** The colour of letters is black if there is evaluation “passed” in tables.

The complete evaluation of each laboratory concerning the key comparison reference value in different flow rates is summarised in the *table 4*.

Flow rate	Independent laboratory	Dependent laboratories	
Q	<b>France</b>	<b>Denmark</b>	<b>Czech Republic</b>
10000	passed	passed	passed
8000	passed	passed	passed
6500	passed	passed	passed
5000	passed	passed	passed
4000	passed	passed	passed
3000	passed	passed	passed
2000	passed	passed	passed
1000	warning	passed	passed
<b>Mean</b>	<b>passed</b>	<b>passed</b>	<b>passed</b>

*Table 4 – Evaluation summary of each laboratory from the point of view of key comparison reference values in different flow rates*

The error curves of all participants and of the key comparison reference values are summarised in the graph mentioned down.

### EURAMET Project no. 1469

